

 **PSU EN54-4 Power Supplies**



Ordering:

Models, Sales Order Parts:	
 PSU MXP-549 : 1.5A PSE in 7Ah enclosure MXP-550 : 3.0A PSE in 17/18Ah enclosure MXP-550D : 3.0A PSE in 25Ah enclosure MXP-551 : 5.0A PSE in 17/18Ah enclosure MXP-551D : 5.0A PSE in 38Ah enclosure Mxp-049 : 1.5A PSE in 7Ah enclosure Mxp-050-001 : 3.0A PSE in 7Ah enclosure Mxp-050-002 : 3.0A PSE in 17Ah enclosure Mxp-051 : 5.0A PSE in 17Ah enclosure Mxp-051/D : 5.0A PSE in 38Ah enclosure	SPARES: Mxs-049 : 1.5A Caged Unit only Mxs-050 : 3.0A Caged Unit only Mxs-051 : 5.0A Caged Unit only (Supplied with AC lead and terminal block) Mxp-501 : Remote Temp Sensor
Applications / Limitations:	
For any fire alarm system that specifies EN54-4 power supplies (e.g. BS5839 code of practice).	
Compatibility:	
These power supply units can be used in fire alarm installations requiring a 24Volt supply for operation.	

	0086-CPR-536903 14
EN54-4: 1997 +A1:2002 +A2:2006 Power supply equipment for fire detection and fire alarm systems for buildings	
Mxp-049, Mxp-050-001, Mxp-050-002, Mxp-051, Mxp-051/D Mxp-549, Mxp-550, Mxp-550/D, Mxp-551, Mxp-551/D	

Specifications:

Item	Specification Details
Approvals	All Power Supply Units comply with the requirements of EN54-4:1997 +A1:2002 +A2:2006, EN55022 class B emissions limits & EN60950-1:2006 safety standards.
Input Supply	1.5A PSE : 220-240V AC, 50/60Hz, Fuse T3.15H250 3.0A/5.0A PSE : 200-240V AC, 50/60Hz, Fuse T3.15H250
Output Voltage	Max 28.5V DC, Min 19.7V DC at minimum battery voltage of 21V ¹ with mains disconnected (Output voltage is $V_{BAT} - 1.3V$ max. at $I_{max.a}$) Ripple 200mV max (Note: 1V p-p including switching frequency noise).
Charger Voltage	27.4V DC nominal at 20°C temperature compensated over the range -5°C to +40°C
Output Current ($I_{max.a} = I_{max.b}$) ($I_{min} = 10mA$)	1.5A PSE : 1.0A continuous load, 0.5A battery charge 3.0A PSE : 2.0A continuous load, 1.0A battery charge [3.0A to load if configured for PSE only ²] 5.0A PSE : 3.0A continuous load, 2.0A battery charge [5.0A to load if configured for PSE only ²]
Dimensions Enclosure IP30 (H x W x D)	MXP-049 : 320 x 345 x 88mm 3Kg without batteries MXP-050-001 : 320 x 345 x 88mm 3Kg without batteries MXP-050-002 : 425 x 406 x 125mm 5Kg without batteries MXP-051 : 425 x 406 x 125mm 5Kg without batteries MXP-051/D : 425 x 406 x 190mm 7Kg without batteries MXP-549 : 263 x 246 x 85mm 3Kg without batteries MXP-550 : 378 x 338 x 110mm 5Kg without batteries MXP-550D : 410 x 363 x 185mm 7Kg without batteries MXP-551 : 378 x 338 x 110mm 5Kg without batteries MXP-551D : 410 x 363 x 185mm 7Kg without batteries
Dimensions Cage (H x W x D)	1.5A PSE : 105 x 94 x 38mm 250g 3.0/5.0A PSE : 184 x 94 x 58mm 690g
Environment	Indoor, Dry
Operating Temperature	-5°C to +40°C @ full load output
Relative Humidity	95% non-condensing (maximum)
Standby Battery and Internal Resistance	2 x 12V Sealed Lead-Acid Type (Yuasa or Powersonic recommended) 1.5A PSE : 3.3Ω 1.2Ah minimum to 7Ah maximum 3.0A PSE : 1.6Ω 1.2Ah minimum to 18/24Ah maximum 5.0A PSE : 0.8Ω 1.2Ah minimum to 38Ah maximum
Fault Output	Volt free change-over contacts rated 1A @ 30V dc (all models)
External Indication	Green: Power indicator, Amber: Fault indicator
On board indication	Mains Fail, Charger Fail, Battery open circuit, Battery Low & Heartbeat
Deep Discharge	All models incorporate battery deep discharge protection (19V)

As our policy is one of constant product improvement the right is therefore reserved to modify product specifications without prior notice. E&OE

¹ The battery final discharge voltage recommended by battery manufacturer.

² NOT EN54-4 Compliant. EN54-4 specifies the provision of two power sources. These should comprise a main supply (AC mains) and a stand-by supply (battery).

Table of Contents

Page

1	INTRODUCTION	4
2	EN54 FUNCTIONS	5
3	INSTALLATION:	5
3.1	MOUNTING INSTRUCTIONS:	6
3.1.1	Mxp-049, Mxp-050, Mxp-051	6
3.1.1.1	Mounting Peripheral Cards or OEM equipment.....	6
3.1.1.2	Fixing Points and Dimensions	6
3.1.2	Mxp-549, Mxp-550, Mxp-551	7
3.1.2.1	Fixing Points and Dimensions	7
3.1.2.2	Mounting batteries	8
3.1.3	Mxs-049, Mxs-050, Mxs-051 PSE Modules.....	8
3.2	WIRING INSTALLATION	9
3.2.1	AC Mains Wiring	9
3.2.1.1	Cable Gland	9
3.2.2	Output Connections:	10
3.2.2.1	To Load:	10
3.2.2.2	To Battery:.....	10
3.2.2.3	Fault Output Connections:.....	10
3.2.2.4	Remote LED indication:.....	11
3.2.2.5	Charger / PSE Only Configuration:.....	11
3.2.2.6	Serial Communications:.....	11
3.2.2.7	Remote Temperature Sensor	12
4	COMMISSIONING:	13
5	MAINTENANCE:	14
5.1	STANDBY BATTERIES	14

1 Introduction

The Advanced 1.5A, 3.0A and 5.0A Power Supply Units can be used for any fire alarm system installation that specifies EN54-4 Power Supply Equipment.

Suited for almost any application (except for CIE in separate cabinet), the power supply unit/battery charger has been developed using the latest surface mount technology to provide a high efficiency switch mode power supply.

The power supply units are available in fully enclosed construction providing power and fault indication or alternatively in caged versions for mounting into existing enclosures of various sizes to suit different battery capacities.

Features

- A range of power supply equipment with power output options to suit most applications.
- Wide AC Input range on the 3.0A and 5.0A versions
- PSE and Charger or PSE only options on the 3.0A and 5.0A versions.
- A Serial Link option is provided on the 3.0A and 5.0A versions. Allows reporting of PSE status and voltages to compatible control panel / modules.
- All models monitor the battery internal series resistance.
- A Remote battery sensing option is provided on the 3.0A and 5.0A versions.

2 EN54 Functions

	<p>This Fire Alarm Power Supply complies with the requirements of EN54-4.</p>
---	---

	<p>P.S.E Functions</p> <p>Operation from a main power supply</p> <p>Operation from a standby battery</p> <p>Monitor and Charge the Standby Battery</p> <p>Recognise and Notify Supply Faults</p>	<p>EN54-4 Clause</p> <p>5.1</p> <p>5.2</p> <p>5.3</p> <p>5.4</p>
---	---	---

The power supplies comprise an AC Mains input circuit (refer to specifications), a single output DC voltage supply circuit³ and a battery circuit.

3 Installation:

These instructions cover the installation, commissioning and maintenance of the Mxp-049, Mxp-050, Mxp-051 and Mxp-549, Mxp-550, Mxp-551 models.

For use of the Mxs-049, Mxs-050 & Mxs-051 in an OEM / customer supplied enclosure, these power supplies should be mounted in an appropriate sized enclosure suitable for the intended batteries to be used. The minimum protection rating of the enclosure must be to IP30 and the power supply must be earthed. Take note of the important safety information in the remainder of this document. An input supply lead with AC Mains Terminal Block is supplied in the kit.⁴

NB: The batteries must not be mounted in an enclosure separate from the power supply since this could affect the temperature compensating charging characteristics, resulting in incorrectly charged batteries.

The power supply modules are also incorporated into other boxed peripheral units. The information in this document is applicable to these power supplies. Refer to the additional data sheet supplied with each boxed unit for details on the installation, configuration and use of the peripheral function.

³ EN54-4 requires that when an EN54-2 CIE is housed in a separate cabinet to the EN54-4 PSE, the CIE shall be supplied via at least two monitored supply (transmission path) circuits such that a short or open circuit in one circuit does not prevent supply of power to the CIE.

⁴ Advanced Electronics Ltd does not warrant that the equipment continues to satisfy the requirements for compliance with the EMC Emissions Directive, Low Voltage Directive or EN54-4 when caged units are mounted in a customer's own enclosure. Ensure continued compliance through appropriate testing and/or notified body certification.

3.1 Mounting Instructions:

3.1.1 Mxp-049, Mxp-050, Mxp-051

The Mxp-049, Mxp-050 and Mxp-051 are power supplies mounted within an IP30 steel enclosure. These can accommodate 7Ah, 18Ah up to 38Ah capacity batteries depending on enclosure size (refer to specifications page).

When batteries are installed, the Mxp-051 can weigh in excess of 16Kg. Use appropriate fixing hardware to secure the panel to the wall.

For example, drill the required holes in the supporting wall using a drill bit diameter 7.0 mm and plug with a suitable 40mm long expansion plug. Affix the panel to the wall with M5 screws (length 40mm) or No.10 screws (length 1½”).

Ensure that there is sufficient space to allow the cover to be removed / opened when the panel is finally mounted.

An example of the Mxp-051 is shown opposite.

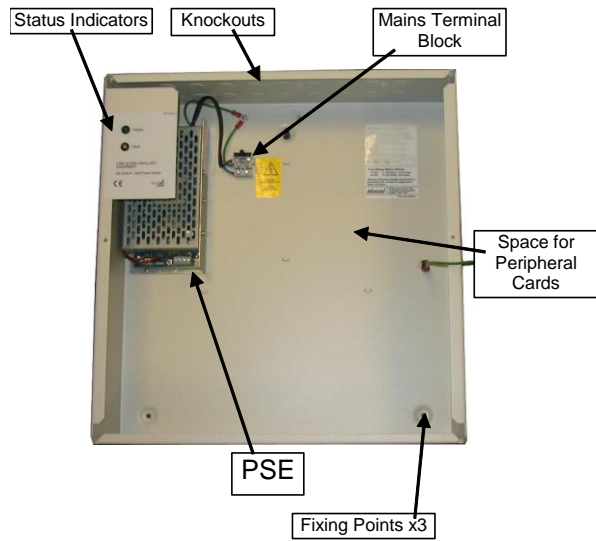

3.1.1.1 Mounting Peripheral Cards or OEM equipment.

Space is provided in which to mount ancillary equipment or printed circuit cards⁵.

3.1.1.2 Fixing Points and Dimensions

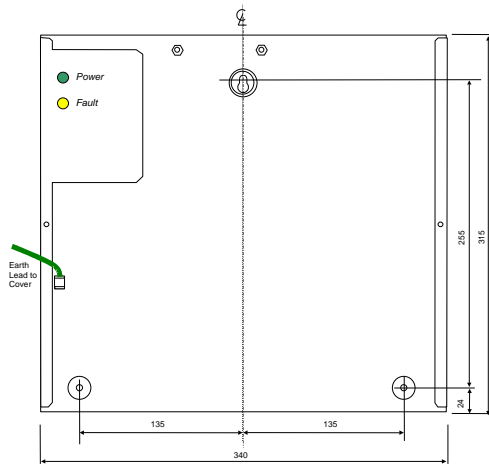

7Ah Enclosure

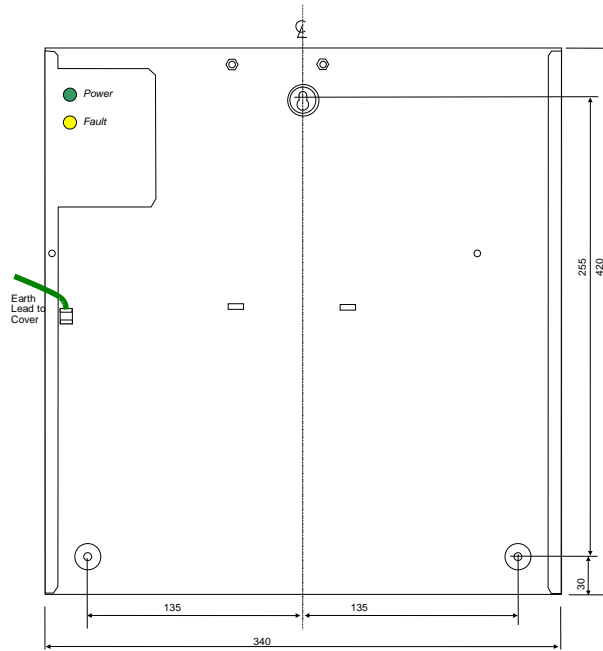

17Ah / 38Ah Enclosure

⁵ Advanced Electronics Ltd does not warrant that the equipment continues to satisfy the requirements for compliance with the EMC Emissions Directive and Low Voltage Directive when equipment, other than that manufactured by Advanced Electronics Ltd and installed in accordance with the supplied documentation, is mounted in the enclosure. Ensure continued compliance through appropriate testing and/or notified body certification.

3.1.2 Mxp-549, Mxp-550, Mxp-551

The Mxp-549, Mxp-550 and Mxp-551 are power supplies mounted within an IP30 steel enclosure. These can accommodate 7Ah, 18Ah up to 38Ah capacity batteries depending on enclosure size (refer to specifications page).

When batteries are installed, the Mxp-551 can weigh in excess of 16Kg. Use appropriate fixing hardware to secure the panel to the wall.

For example, drill the required holes in the supporting wall using a drill bit diameter 7.0 mm and plug with a suitable 40mm long expansion plug. Affix the panel to the wall with M5 screws (length 40mm) or No.10 screws (length 1½”).

The cover is hinged on the left hand side. Ensure that there is sufficient space to allow the cover to be opened when the panel is finally mounted.



3.1.2.1 Fixing Points and Dimensions

MXP-549

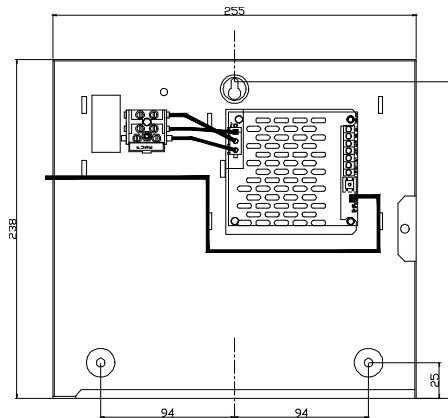
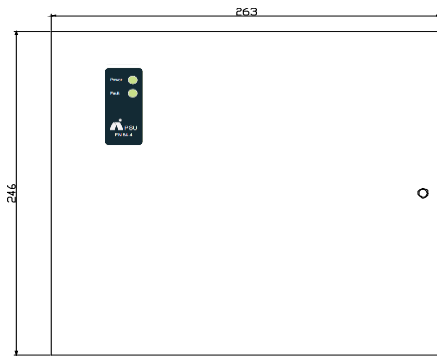

Note: This unit does not accept the Mxs-049 module. The PSE PCB and cage are mounted directly to the back box.

MXP-550 & MXP-551

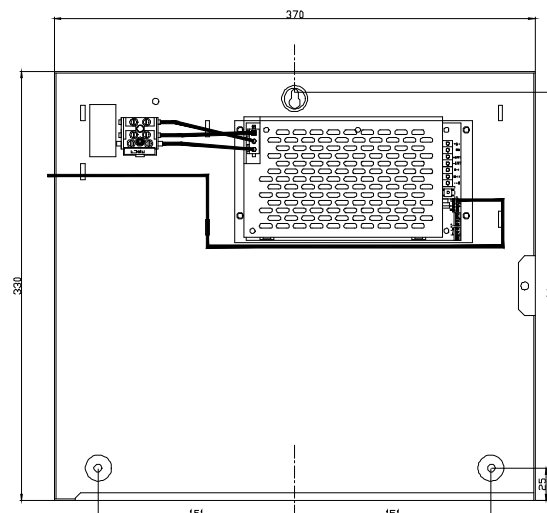
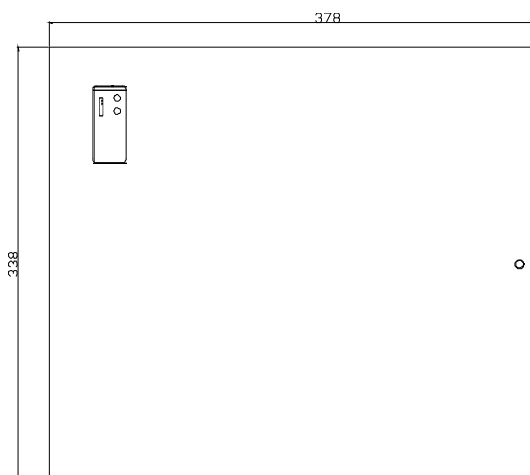

MXP-550/D & MXP-551/D

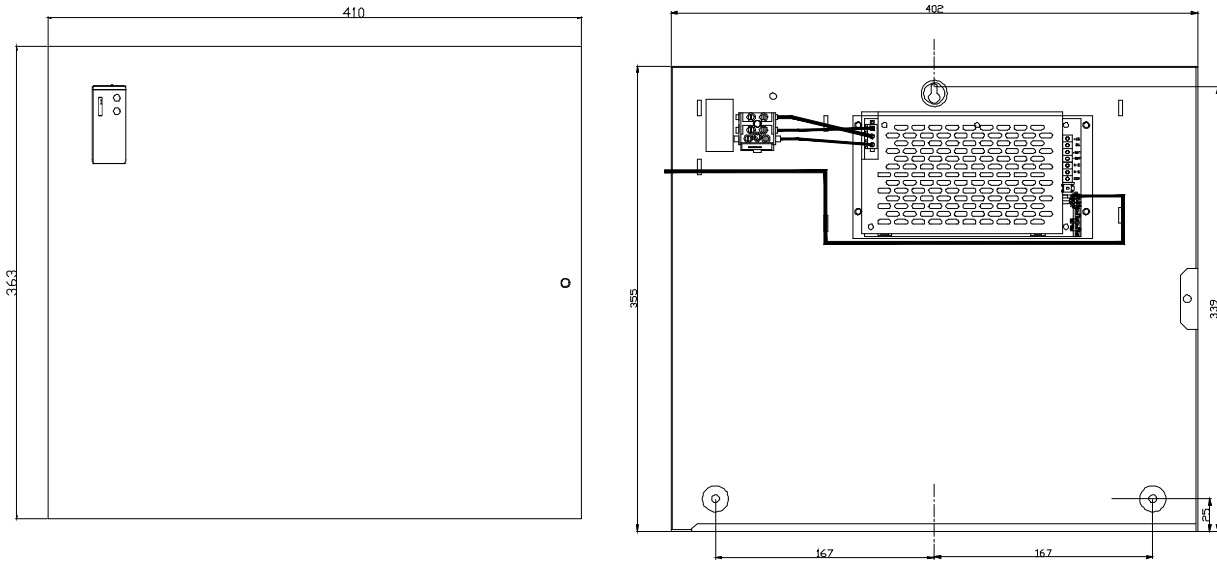

3.1.2.2 Mounting batteries

MXP-549

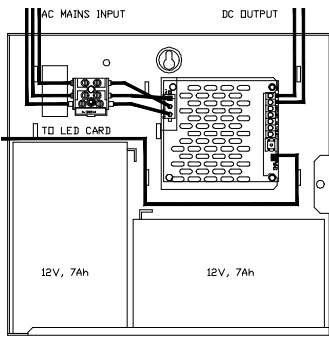

MXP-550 & MXP-551

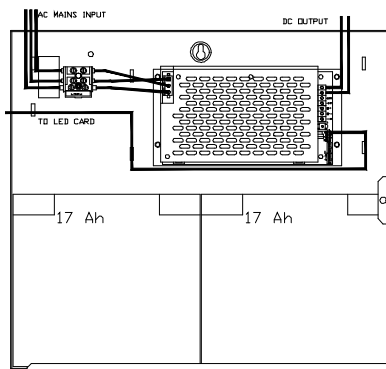

MXP-550/D & MXP-551/D

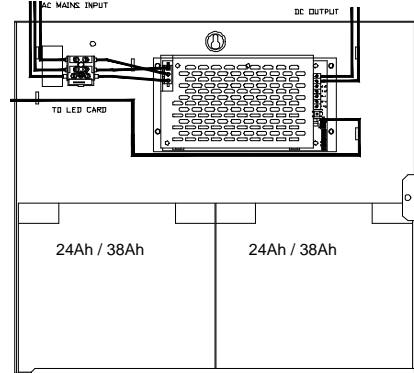

3.1.3 Mxs-049, Mxs-050, Mxs-051 PSE Modules

The PSE modules can be installed in Mx-5000 Rack and other Utility enclosures.

Refer to the relevant product manuals for further information.



The dimensions and fixing points are shown below.

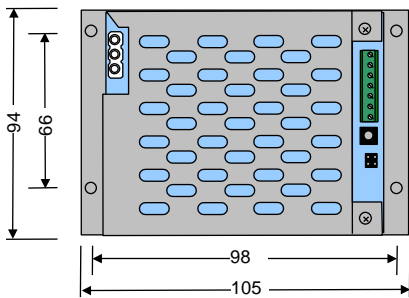

1.5A PSE

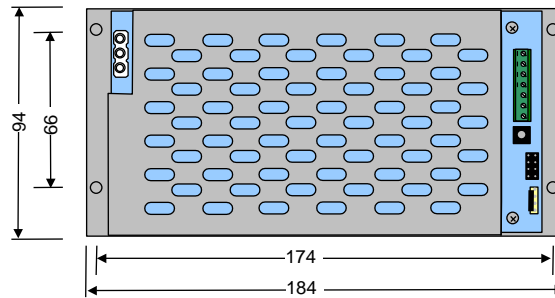

3.0A / 5.0A PSE

3.2 Wiring Installation

3.2.1 AC Mains Wiring

The power supply is classified as Class1 equipment construction and must be earthed in accordance to EN60950 recommendations.

Route the high voltage mains AC wiring into the enclosure using a suitable knockout and keeping the AC wiring away from any circuit boards and all other wiring.



The panel must be connected to the supply earth through the power cable.

The mains input connector is shown in the diagram opposite. Note the positions of the earth, neutral and live terminal connections.

These are clearly marked on the label next to the connector. The connector block contains an integral fuse holder for a 20mm fuse.

Secure the mains input wiring using a tie wrap as close to the terminal block as possible.

The fuses are rated as follows:

T 3.15A H 250V (for all models)

Replace with correct rating and specification only.

Connect the PSE to the mains supply via a readily accessible, disconnect device (Isolation Switch) and suitable earth fault protection incorporated in the building installation wiring.

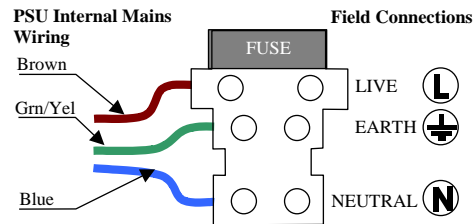

AC Mains terminations – Mxp-049

The Mains cable should be a minimum cable size of 0.5mm² for the 1.5A PSE & 0.75mm² for the 3.0A/5.0A PSE rated at 250V and fused via a 5A anti-surge fuse. Maximum cable size is limited to 4mm².

Keep all mains wiring separate from the Extra Low Voltage (ELV) battery cables and power supply output cables.

3.2.1.1 Cable Gland



The cable gland and any cord clamp bushings used in routing the Mains cable through the 20mm knockout must have a minimum flame-retardant rating of 94HB.

Suggested glands and bushings are: -

Type	Manufacturer
Gland IP65 – Brass M20, EExd / Eexe	Lapcable
Gland IP68 – Nylon 66 M20 Black, UL94V2	Multicomp
Bushing – Nylon 66 M20 Black, UL94V2	Multipcomp

3.2.2 Output Connections:

3.2.2.1 To Load:

Connect the 28V output connections to the load via terminals **VO+ & VO-** respectively via appropriately rated cable for the output rating:

For 3.0A/5.0A PSE a minimum 0.75 mm²

For 1.5A PSE a minimum of 0.22mm²

NB Maximum cable size is limited to 2.5mm²

Refer to diagrams opposite for the positions of all output connections.

Maximum Cable Resistance:

The voltage drop on the output circuit should be calculated to ensure that the minimum voltage at the end of the circuit exceeds the minimum required by the device at the minimum PSE output voltage.

The voltage at the end of the circuit is given by:

$$\text{Minimum Load Voltage} = V_{\text{OUT(MIN)}} - (I_{\text{LOAD}} \times R_{\text{CABLE}})$$

Minimum Output Voltage ($V_{\text{OUT(MIN)}}$) is $V_{\text{BAT(MIN)}} - 0.5V = 20.5V$

Load Current (I_{LOAD}) is the sum of the loads presented by the devices.

Cable Resistance (R_{CABLE}) is the sum of the cable resistance in both cores x cable length.

Cable Resistance (R_{CABLE}) for 1.0mm² is 0.036Ω / m

Cable Resistance (R_{CABLE}) for 1.5mm² is 0.024Ω / m

Cable Resistance (R_{CABLE}) for 2.5mm² is 0.015Ω / m

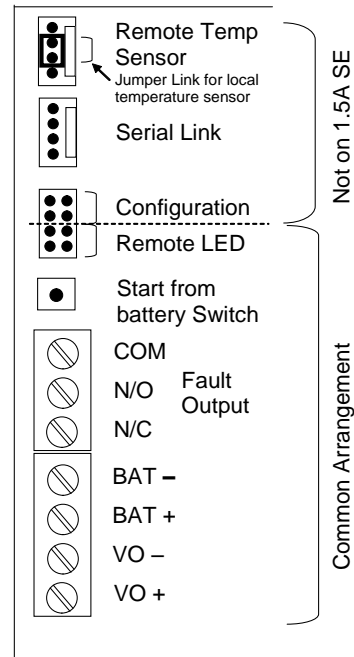

Observe that the load is connected with the correct polarity!

Route the wiring away from any mains connections.

3.2.2.2 To Battery:

The system is designed to charge 24V batteries or two 12V batteries connected in series. Refer to diagram opposite.

Use the short black connection link to connect the batteries.

Use the Red & Black leads provided to connect the batteries to the **BAT+ & BAT-** terminals on the PSU.

Take care to observe the correct polarity and ensure the battery leads do not become shorted together!

Mount the batteries on the bottom of the enclosure.

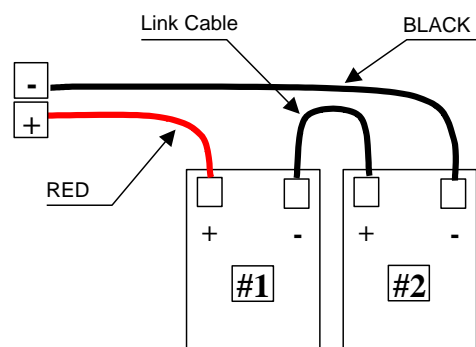

3.2.2.3 Fault Output Connections:

Power supply/charger fault outputs are provided for in the form of volt free changeover contacts designated **COM, N/O & N/C**. These are available via three terminal blocks screws – refer to diagram above.

The “Fault” relay is held in a normally energised state. It will fail to safety (de-energise) under any power supply/charger “Fault” conditions.

3.2.2.4 Remote LED indication:

A pin header, J1, provides a means for remote/ external indication of “Power” and “Fault” indications.

The Mxp-049, Mxp-050 & Mxp-051 models are supplied fitted with separate Green and Amber LED Indicators. Refer to diagram below for how to connect these assemblies to the PSU.

Replacement parts are available. Green = Mxs-026-GRN and Amber = Mxs-026-YEL

The Mxp-549, Mxp-550 & Mxp-551 are supplied with an LED PCB mounted on the cover. This is connected to the PSE module using a 4-Way cable.

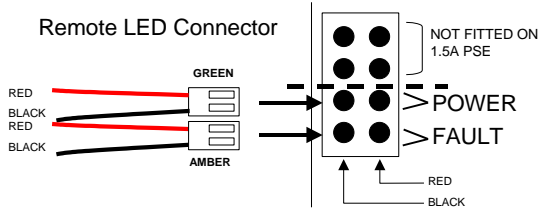

The Green “Power” indicator will be ON continuously when the power supply is being supplied with mains power. This indicator will flash when the mains supply is off and the power supply is being powered from its battery source.

The Amber “Fault” indicator will be ON continuously if any of the Fault conditions listed opposite are present:

Note: Faults may not be indicated immediately. They will be indicated within the times permitted in EN54-4 (see opposite for nominal times).

3.2.2.5 Charger / PSE Only⁶ Configuration:

The 3.0A and 5.0A PSE models can be configured for operation as a PSE + CHARGER or PSE ONLY (if battery standby is not required).

A pin header, J1, provides a means for selecting this operation.

On-board Indicators

The following indicators on the printed circuit card give further diagnostic information.

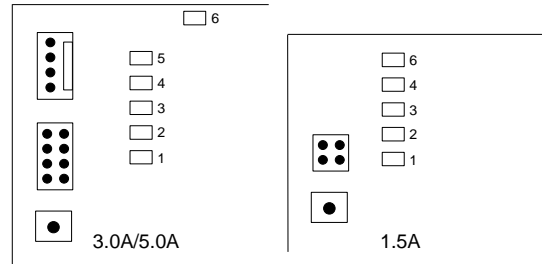

- [1] MAINS FAILURE : AC Mains Supply failure (30 seconds)
- [2] CHARGER FAULT : Battery charger output failure (2 minutes)
- [3] BATTERY OC : Battery disconnected (2 minutes)
- [4] BATTERY LOW : Battery High Cell Resistance (3 minutes)
- [5] BATTERY ON : Output Voltage is supplied from the battery
- [6] HEARTBEAT : Microprocessor is running (flashes)

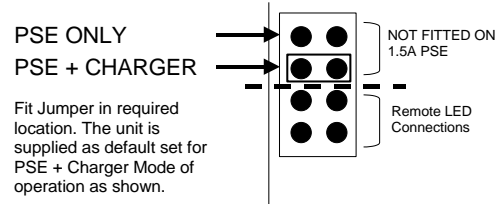

3.2.2.6 Serial Communications:

The 3.0A and 5.0A PSE models can be connected to a compatible control panel or other peripheral module for communication of the PSE status and voltage / current measurements.

A latching pin header, PL2, is provided – see opposite.

Information is provided with the unit / module where this compatible feature is provided.

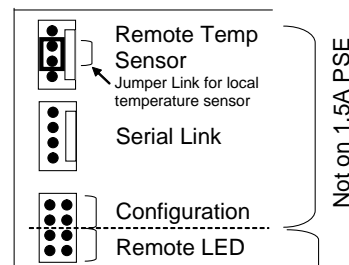

⁶ NOT EN54-4 Compliant. EN54-4 specifies the provision of two power sources. These should comprise a main supply (AC mains) and a stand-by supply (battery).

3.2.2.7 Remote Temperature Sensor

Provision is made on the 3.0A and 5.0A PSE models for the connection of a remote battery temperature sensor (Mxp-501). This is for applications where the modules are installed in rack mount enclosures or in large enclosures and where the batteries are not located immediately next to the module.

A latching pin header, PL3, is provided for connection of the temperature sensor – see opposite and below.

If a remote temperature sensor is not used, ensure the jumper is fitted to the centre two pins.

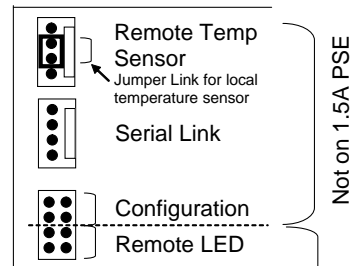

If neither a jumper nor a remote sensor is fitted, the PSE module will indicate a charger fault condition.

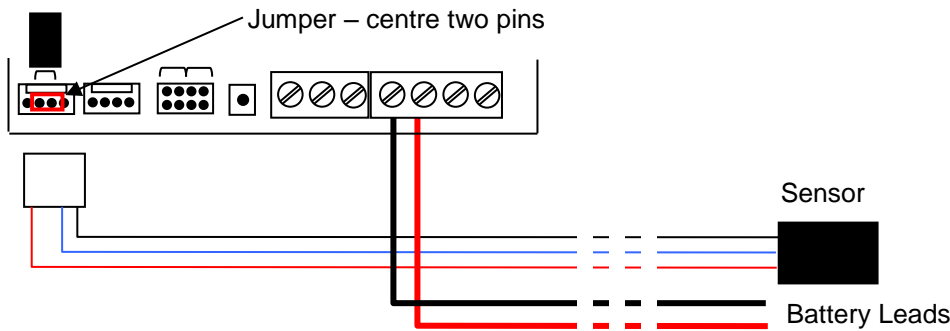

Remove the jumper and plug the Mxp-501 into the connector. Route the sensor cable along with the battery leads. Use the supplied tie-wraps to tie the sensor cable to the battery leads so that the encapsulated sensor is located close to the batteries. The sensor cable is 500mm in length.

4 Commissioning:

When all connections in the Installation section have been made and checked for correct wiring, switch on the mains power supply; the following conditions should occur:

- 1 The green "Power" LED should be ON, the "Fault" LED should be OFF.
- 2 The load should be supplied with power, check this with a voltmeter at the -VO & +VO terminals, the reading should be between 25 & 28.5 volts⁷.
- 3 The batteries should be charging, check this by connecting a voltmeter across the -BAT & +BAT connections, depending on the state of discharge of the batteries, the voltage should be greater than 24 volts and for batteries approaching their full charge, the output voltage should be approximately 27.4 volts at an ambient temperature of 20°C
- 4 All on-board diagnostic LED indicators should be OFF, the "Heartbeat" indicator should be FLASHING.
- 5 The "Fault" relay should be energised. Check that there is a connection between common and normally open (N/O). This connection should indicate a short circuit when checked with a test meter on the continuity setting.

The following table indicates the charger voltage against temperature when the batteries are fully charged.

Ambient Temperature ° C	Charger output voltage (minimum)	Charger output voltage (Nominal)	Charger output voltage (Maximum)
-5	27.90	28.10	28.32
0	27.72	27.96	28.20
5	27.54	27.80	28.08
10	27.36	27.66	27.96
15	27.24	27.50	27.78
20	27.12	27.36	27.60
25	27.00	27.20	27.42
30	26.88	27.06	27.24
35	26.76	26.90	27.06
40	26.64	26.76	26.88

TABLE 1

NB: The charger is designed to charge Yuasa & Powersonic sealed lead acid batteries only. Other manufacturers' batteries may have different temperature / charge characteristics.

⁷ The Output will gradually increase until its optimum level (dependent on temperature) is reached.

5 Maintenance:

Maintenance of the power supply and charger should be minimal. The batteries, however, do have a limited life span and a maintenance program should be in place to determine battery replacement schedules.

It is recommended that the charger output should be checked on a yearly basis to ensure the charging characteristics have not drifted. Refer to Table 1 above for checking this parameter.

5.1 Standby Batteries

Expected Life - 3-5 years at an ambient temperature of 20°C

Replacement Schedule - As above. **However, note that the expected battery life is shortened by an increase in ambient temperature. The life reduces by 50% for every 10°C rise above ambient. This should be taken into account when assessing battery replacement schedules.** Refer to battery manufacturer manuals for further information.

Manufacturer / Part Numbers	-	YUASA		POWERSONIC
		4AH NP4-12		5AH PS-1250-F1
		7AH NP7-12		7AH PS-1270
		12AH NP12-12		12AH PS-12100-F1
		18AH NP18-12		18AH PS-12180-NB
		24AH NP24-12B		26AH PS-12260-NB
		38AH NP38-12		40AH PS-12400



For optimum performance and charge retention, Yuasa recommend that batteries, up to 6 months old from date of manufacture, are 'top-charged' prior to installation.

To perform the top-charging, use a separate supply and charge at 2.4V per cell (i.e. 14.4V per battery) for 20 hours prior to installing the batteries.



It is not recommended to use batteries that are older than 6 months from the date of manufacture on a new installation.



DANGER
Harmful fumes

It is quite normal for lead-acid batteries to vent hydrogen when being charged.

The panel is adequately ventilated to dissipate this hydrogen. DO NOT seal the enclosure or install in a sealed enclosure or cavity.



It is not recommended to use batteries that are older than 6 months from the date of manufacture on a new installation.



BATTERY DISPOSAL

Re-cycle all exhausted batteries.

Return to the battery manufacturer or dispose of batteries in accordance with the applicable local legislation.



USER NOTES

Doc Number: 680-132

Revision: 07



Advanced Electronics Ltd
Moorland Way, Cramlington, Northumberland, NE23 1WE UK

Tel: +44 (0)1670 707 111

Fax: +44 (0)1670 707 222

Email: sales@advancedco.com

Web: www.advancedco.com